

4 Категория сложности фрезеровки



Рис. № 41



Рис. № 47
(16+3)

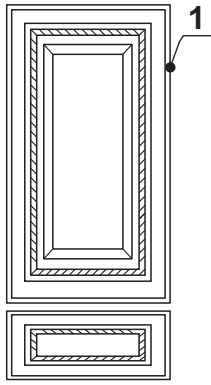

Рис. № 70
(10+8)

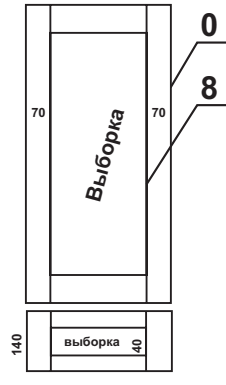

Рис. № 71
(10+8)

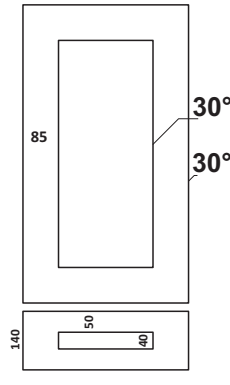

Рис. № 72
(10+8)

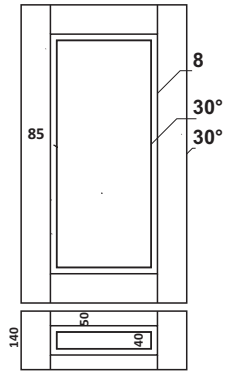

Рис. № 80

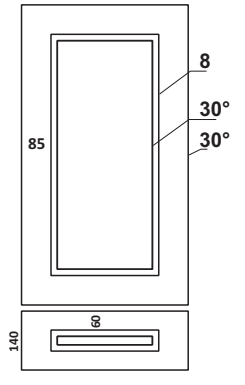

Рис. № 81

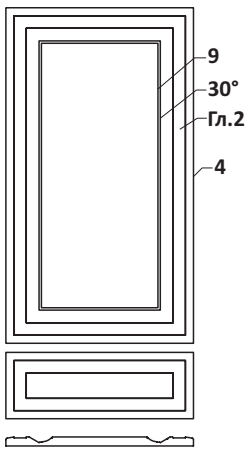

Рис. № 82

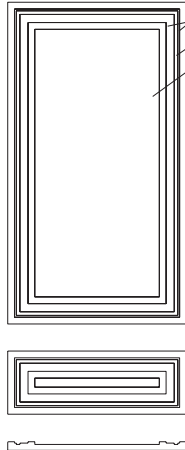

Рис. № 83

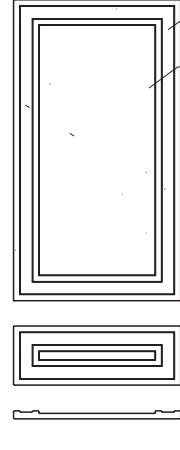

Рис. № 84

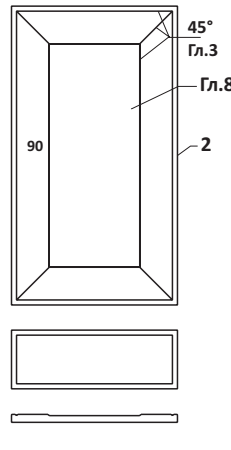

Рис. № 85

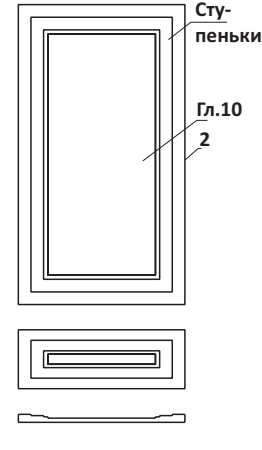

Рис. № 86

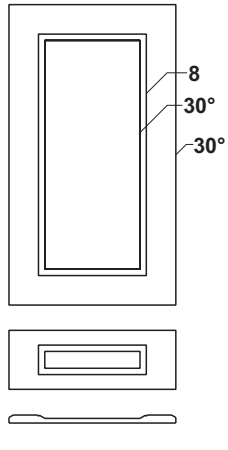

Рис. № 88

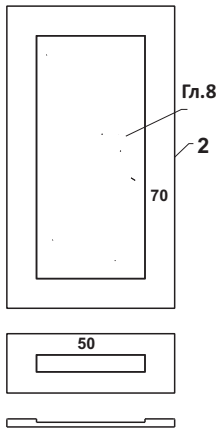

Рис. № 89

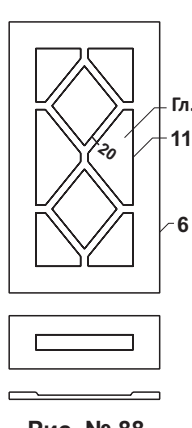

Рис. № 90

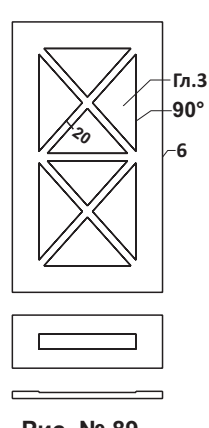

Рис. № 91

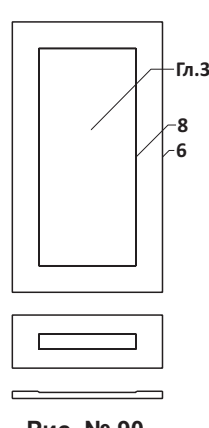

Рис. № 92

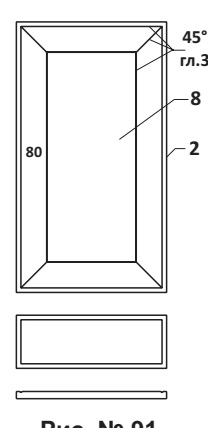

Рис. № 87

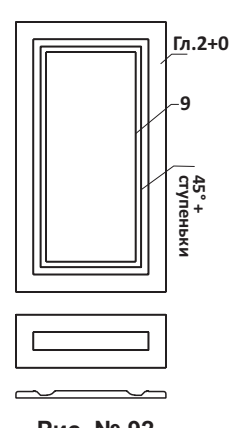

Рис. № 93

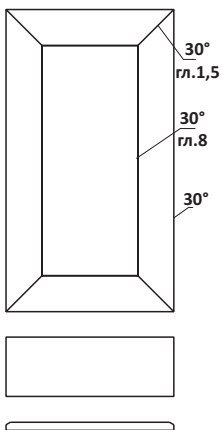

Рис. № 95

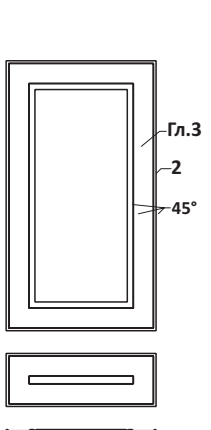

Рис. № 98

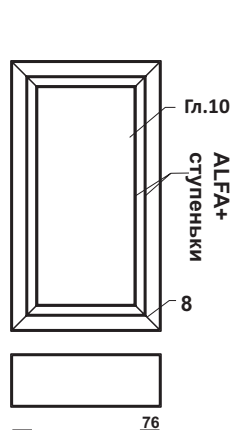

Рис. № 99

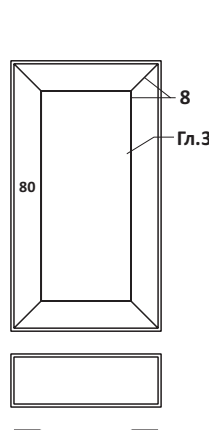

Рис. № 100

4 Категория сложности фрезеровки

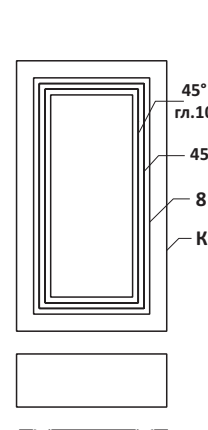

Рис. № 101

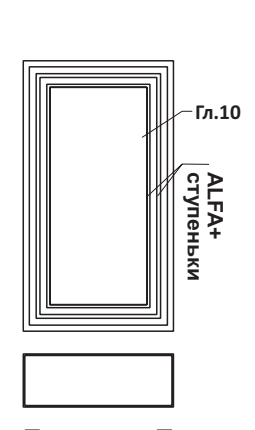

Рис. № 102

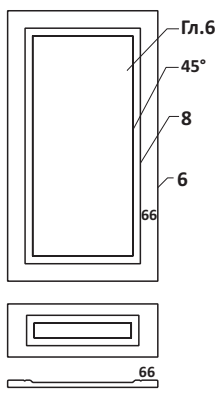

Рис. № 103



Рис. № 107

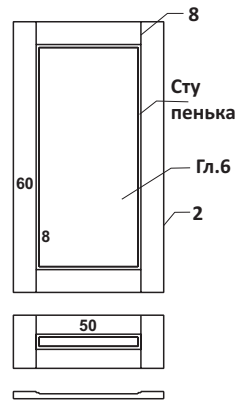

Рис. № 108

3 Категория сложности фрезеровки

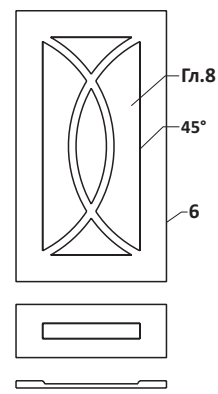

Рис. № 14

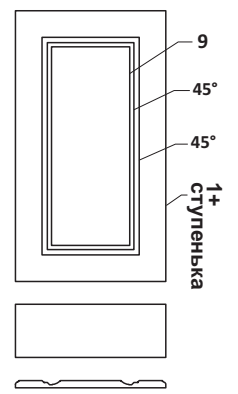

Рис. № 18

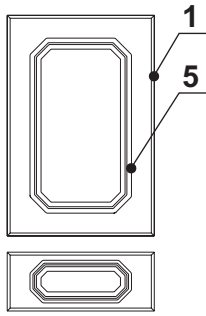

Рис. № 23

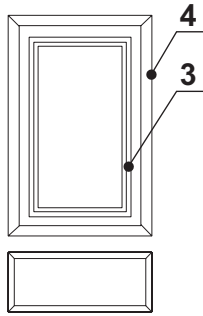

Рис. № 31

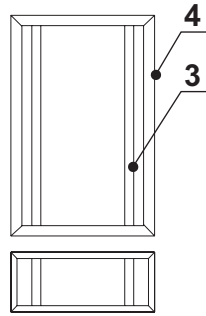

Рис. № 36

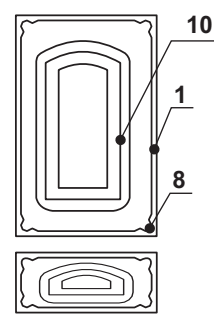

Рис. № 38

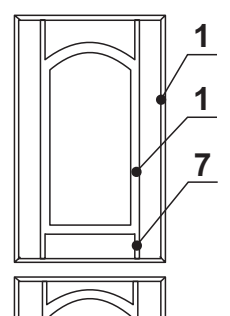

Рис. № 39

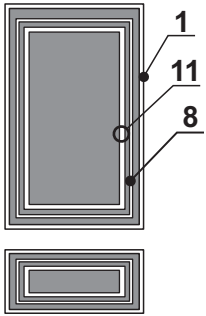

Рис. № 53

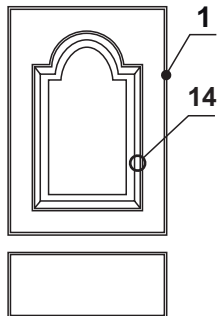

Рис. № 55

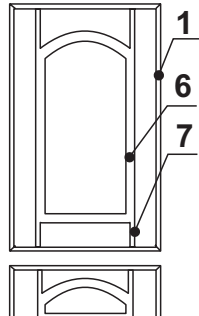

Рис. № 58

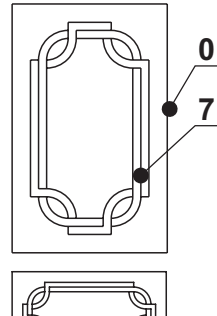

Рис. № 59

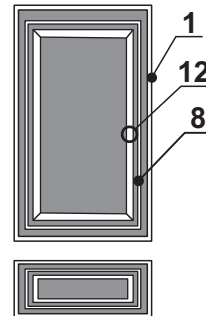

Рис. № 60

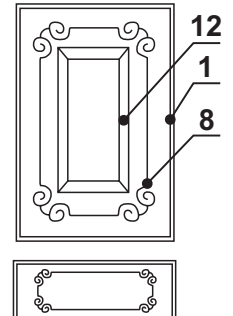

Рис. № 61

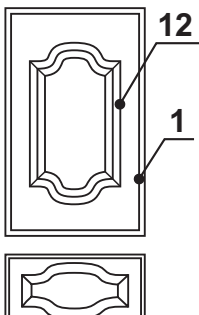

Рис. № 65

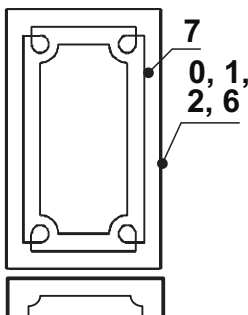

Рис. № 66

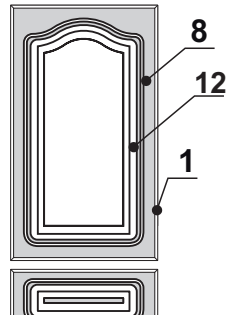

Рис. № 67

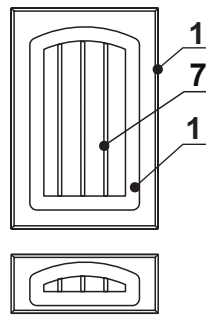

Рис. № 69

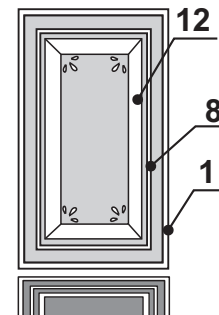

“Вестерн”

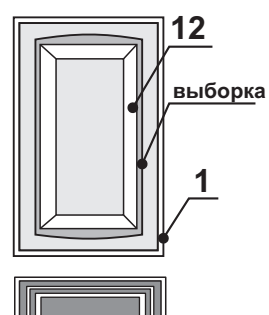
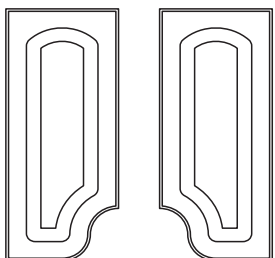
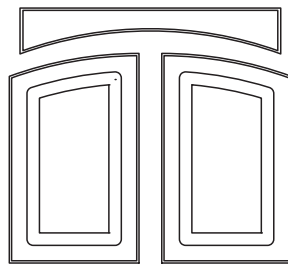

“Кантри”

2

Категория сложности фрезеровки



Рис. № 1

Рис. № 2

Рис. № 3

Рис. № 4

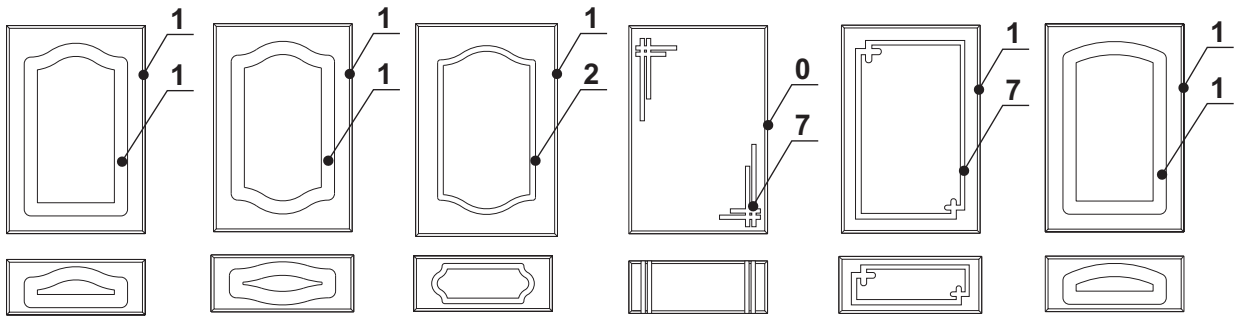
Рис. № 5

Рис. № 6



Рис. № 7

Рис. № 8

Рис. № 9

Рис. № 10

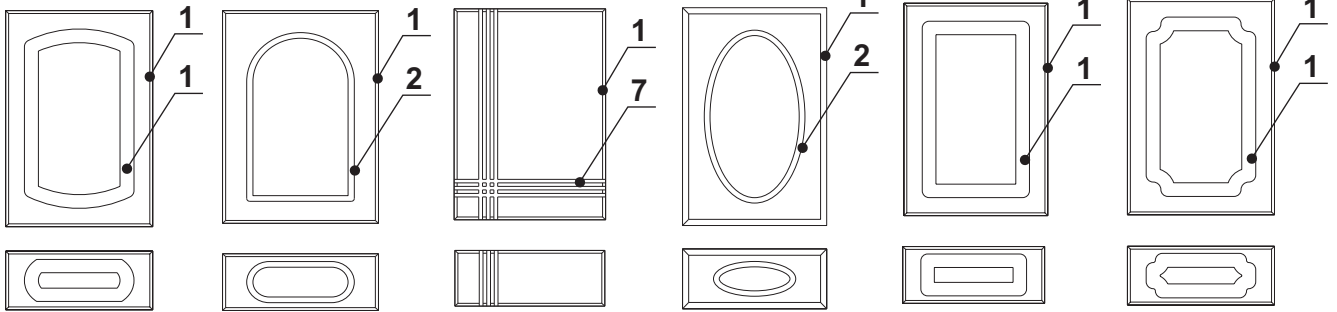
Рис. № 13

Рис. № 15



Рис. № 16

Рис. № 17

Рис. № 26

Рис. № 29

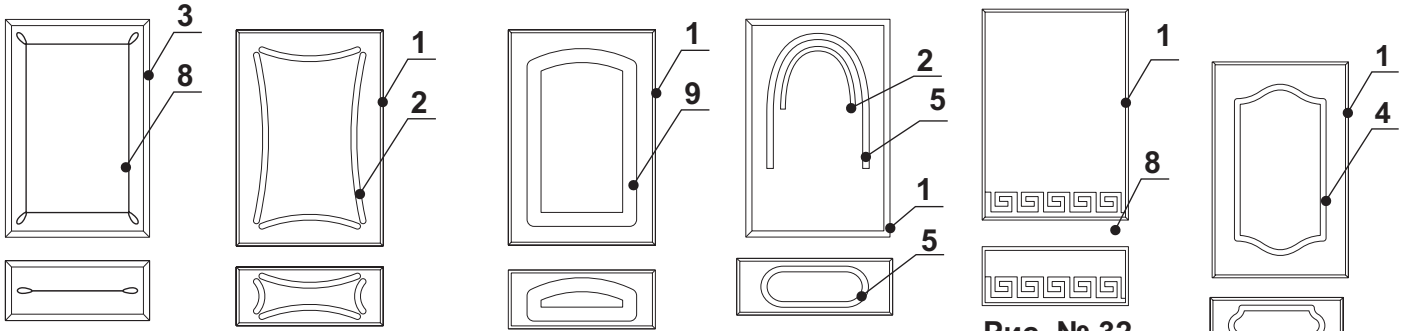
Рис. № 32

Рис. № 49



Рис. № 33

Рис. № 34

Рис. № 35

Рис. № 40

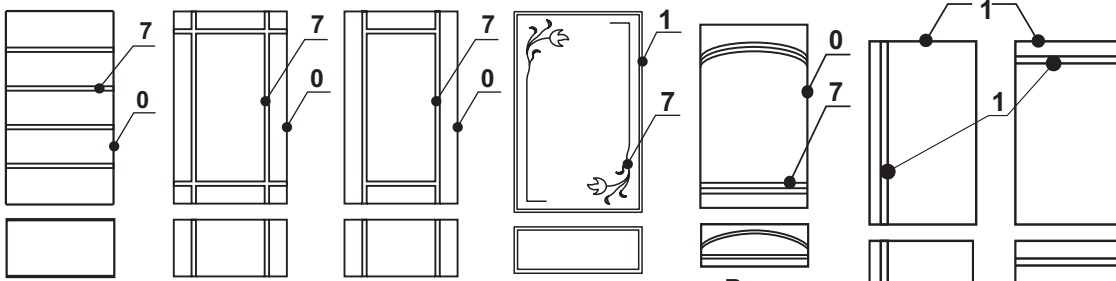
Рис. № 44

Рис. № 45

Рис. № 46

1

Категория сложности фрезеровки



Рис. № 11

Рис. № 12

Рис. № 22

Рис. № 24

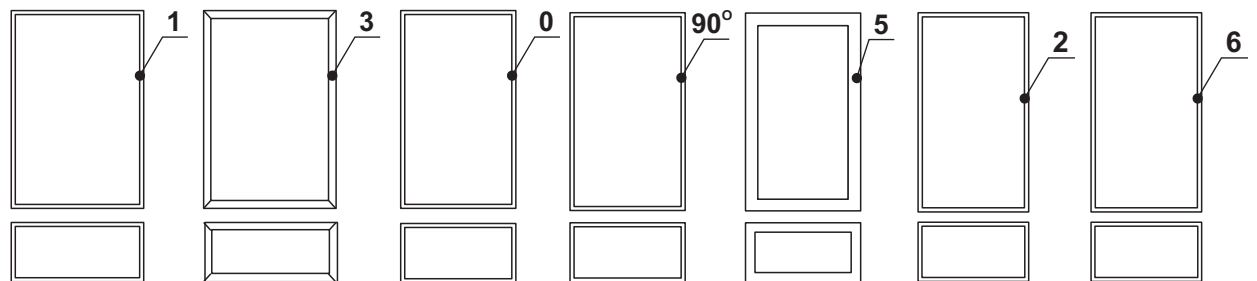
Рис. № 25

Рис. № 30

Рис. № 50

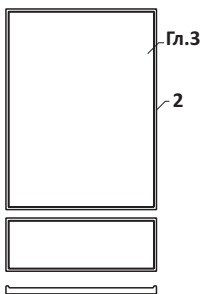

Рис. № 104

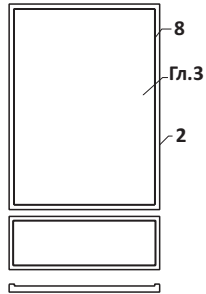

Рис. № 105